













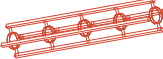



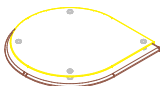
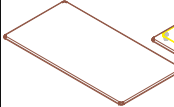
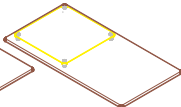

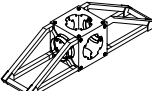











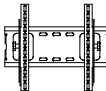





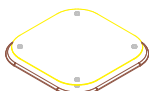
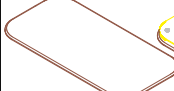
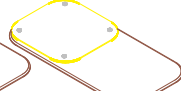

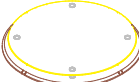
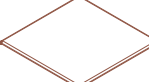
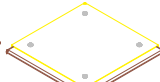

Part Count:

Pavo [OR-K-PA1], 10' x 10' Kit Size

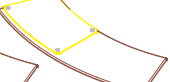

 OR-J-3 10	 OR-J-DBL 00	 OR-24-2 00	 OR-30-2 00	 OR-36-2 05	 OR-46-2 05	 OR-45-CV-3 08	 OR-90-CV-2 00	 OR-PO2-15 00	 OR-PO2-15-P 00	 OR-TC01-15 00	 OR-TC01-P-15 00	
 OR-B90 00	 OR-B90A 00	 OR-B45 00	 OR-TOOL-B 01	 OR-QL-T2J 27	 OR-QL-T2T 06	 OR-UC-QL 00	 OR-STG 00	 OR-PO3-15 00	 OR-PO3-15-P 00	 OR-TC02-15 00	 OR-TC02-P-15 00	
 OR-LCD1-B 00	 OR-LCD2-B 00	 OR-LCD3-B 00	 SPOTLIGHT 04	 OR-TBL 01	 OR-TBL2-L 00	 OR-TBL2-R 00	 OR-PO4-15 00	 OR-PO4-15-P 00	 OR-TC03-15 00	 OR-TC03-P-15 00		
00	OR-IS-24 	00	OR-CIS-90 									
00	OR-IS-36 		OR-SE-IS-90 	00	00	00	00	00	00	00	00	00
00	OR-IS-46 		00									
00	OR-IS-48 											

Note: MDF finishes may vary.

*-S

*-B

*-WD

*-DWD

Graphic Specs:

Pavo [OR-K-PA1], 10' x 10' Kit Size

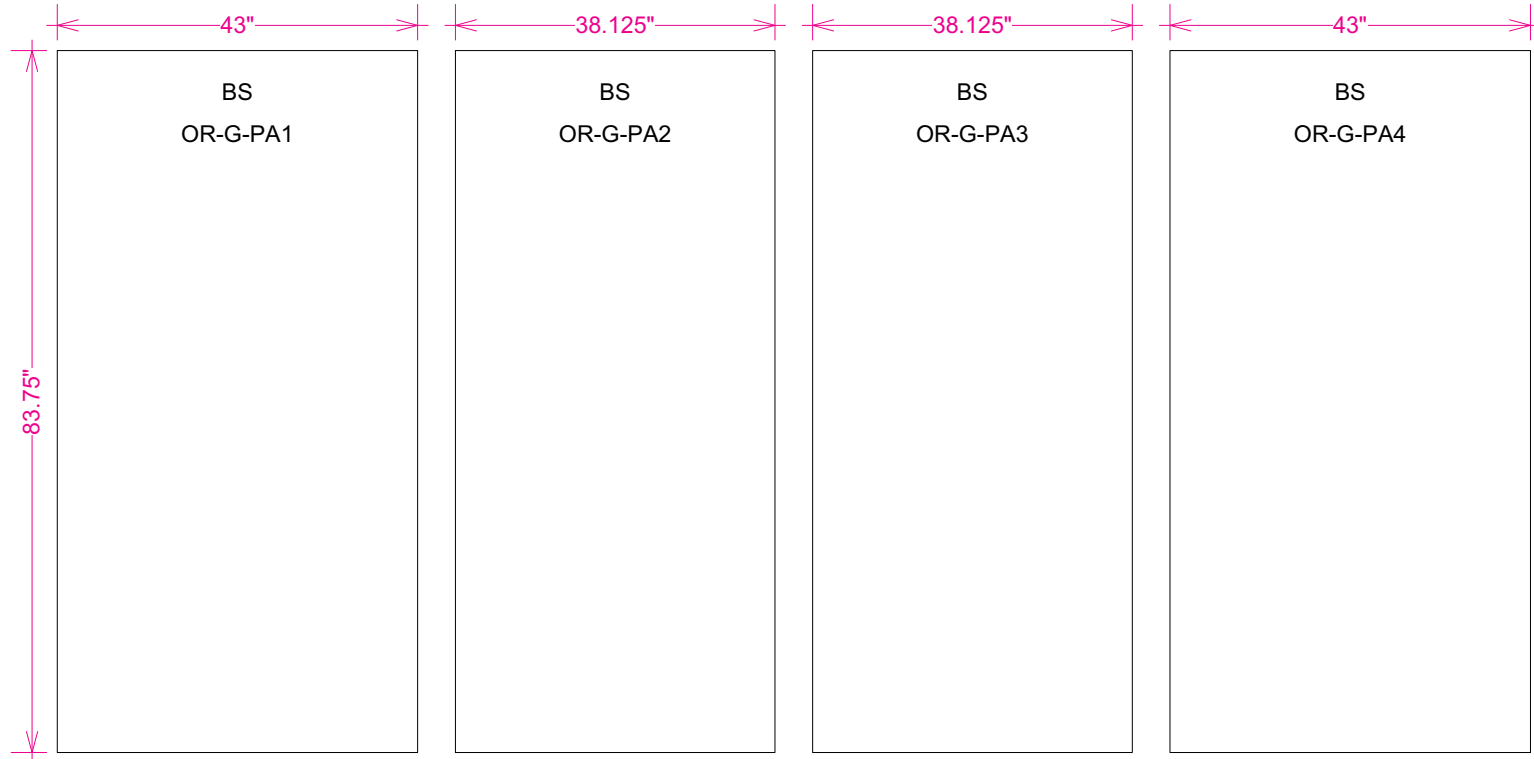

Available Graphics: Dye-Sublimation, Inkjet or UV Graphics

Acceptable File Formats:

Illustrator CS3 or below
Photoshop CS3 or below

Art time will be charged if files need to be fixed or altered to meet guidelines. When sending files please be sure to include all support art (fonts, linked images, etc.)

Font Specifications:

Fonts must be converted to outlines.

Bleeds:

All orbital truss graphics require specific bleeds. The sizes listed above represent the finished graphic size. Please keep all logos, type, and critical information at least 1" in from each edge of the finished graphic.

Dye Sublimation: 2" bleed around the perimeter.

Inkjet & UV: 1/2" bleed around the perimeter.

Color:

All files are printed as CMYK format. All critical Pantone colors need to be called out in the file or specified on the order as Coated or Uncoated swatches.

Resolution:

All raster files (either print files or linked files) must be at 100-120 pixels per inch at 100%.

Finishing Details:

When graphics are notched, a 7/8" square is cut in the appropriate location

FS: Graphics mounted to front of the truss system

BS: Graphics mounted to back of the truss system

Dye Sublimation graphics are attached to truss with velcro. Inkjet & UV panels are attached to truss with magnet.

IMPORTANT INFORMATION REGARDING GRAPHIC FILES: Each graphic has a specific code or number located on the graphic.

The electronic print ready files provided must be named accordingly. Using this coding system will allow us to preflight and prepare your files for print more efficiently.

If you fail to provide your graphic files in this format, additional charges may be necessary to complete your printed materials.

3D Rendering:

Pavo [OR-K-PA1], 10' x 10' Kit Size

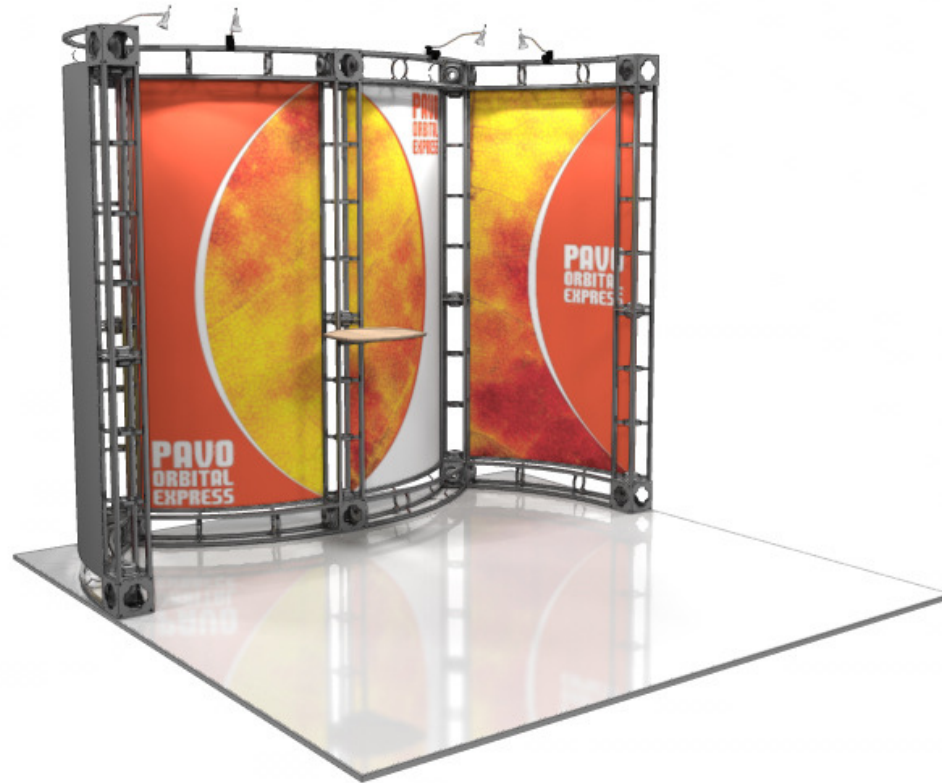

3D Rendering:

Pavo [OR-K-PA1], 10' x 10' Kit Size

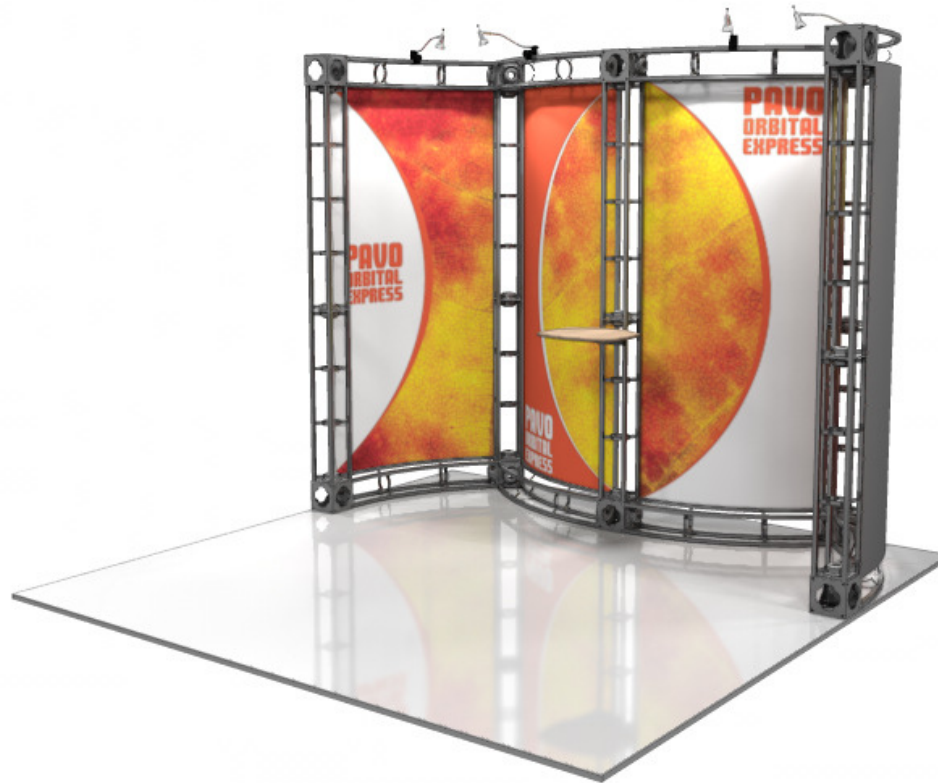

Floor Plan:

Pavo [OR-K-PA1], 10' x 10' Kit Size



SCALE REF = 5ft



10' d X 10' w Inline

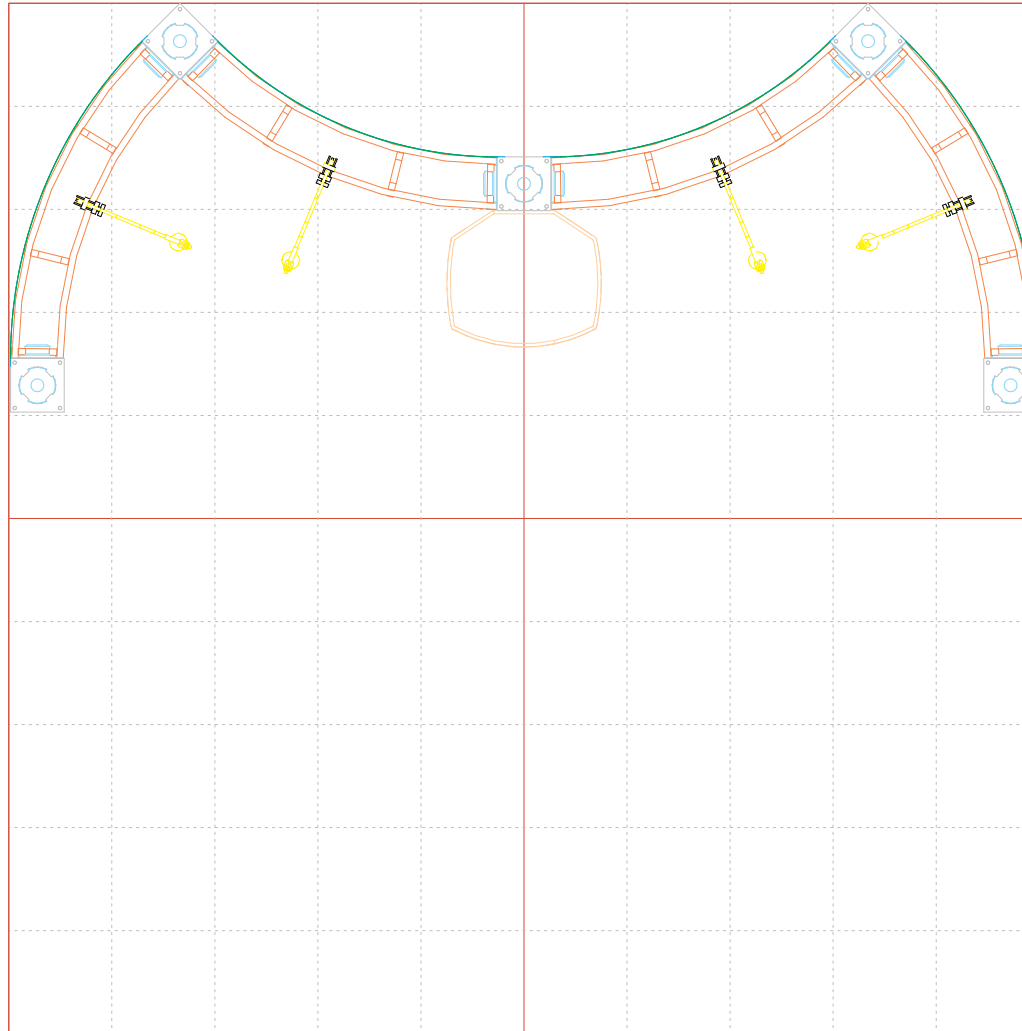

Color Coded Parts:

Pavo [OR-K-PA1], 10' x 10' Kit Size

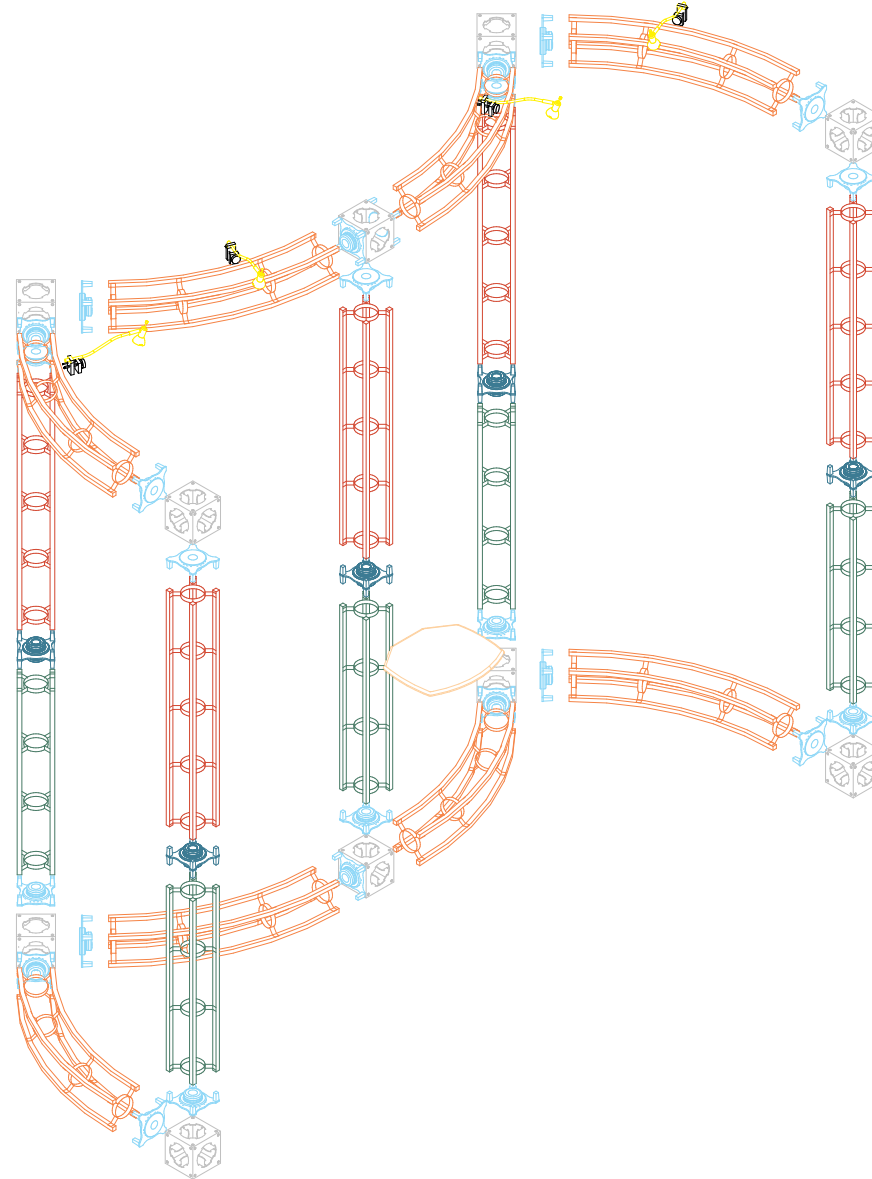

Color Coded Parts:

Pavo [OR-K-PA1], 10' x 10' Kit Size

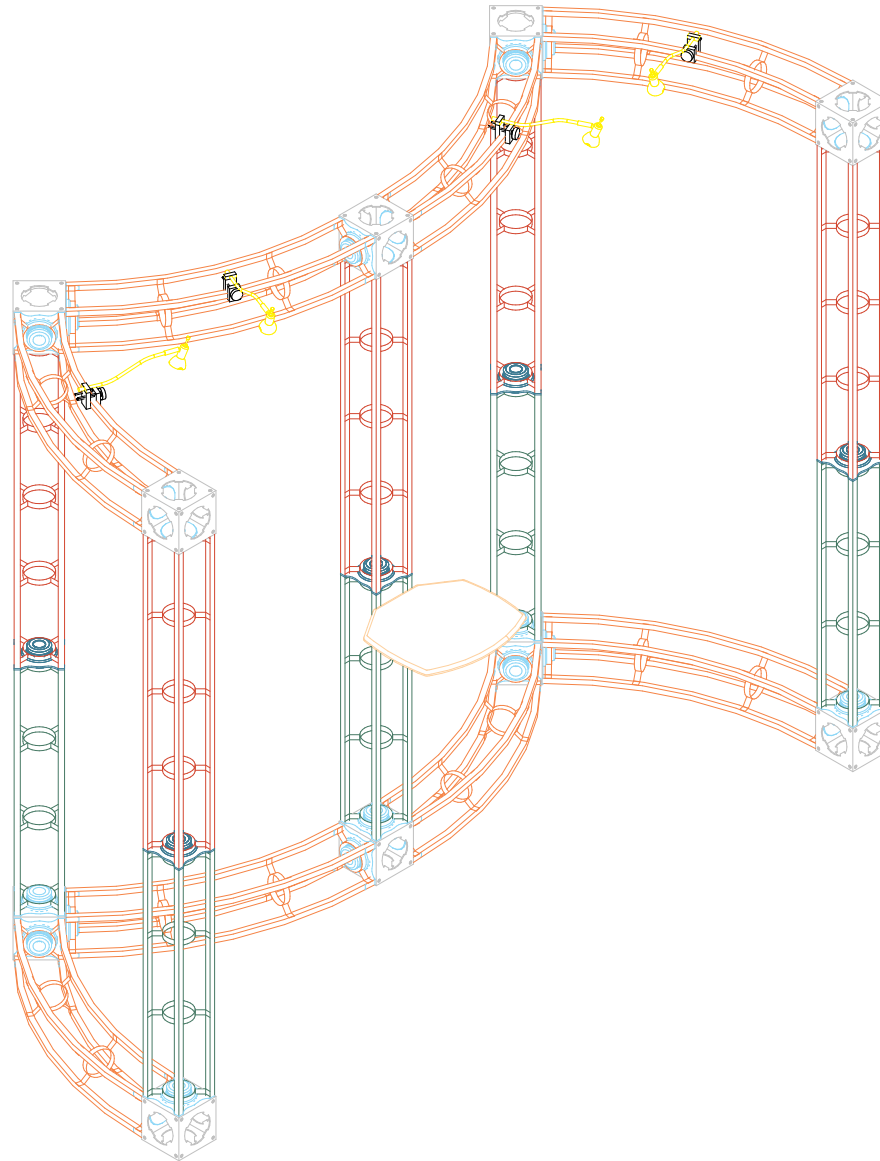

Case Count:

Pavo [OR-K-PA1], 10' x 10' Kit Size

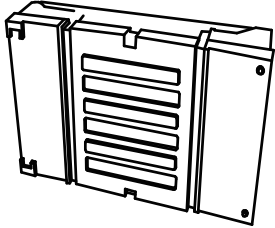

ORBITAL FREIGHT CASE
48" x 36" x 10.5"
(OCFM) **0**

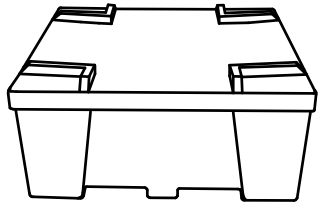

ORBITAL FREIGHT CASE
48" x 36" x 18"
(OCF) **2**

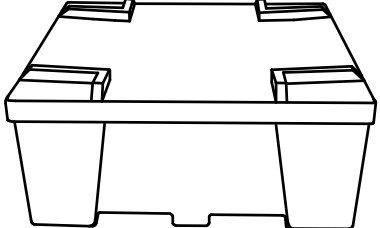

ORBITAL FREIGHT CASE
48" x 48" x 18"
(OCF2) **0**

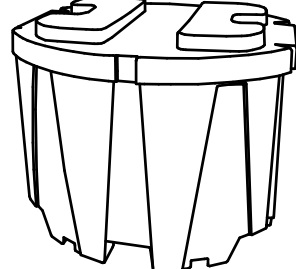

ORBITAL FREIGHT CASE
48" x 44" x 34"
(OCT) **0**

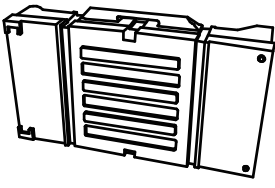

ORBITAL FREIGHT CASE
36" x 24" x 10"
(OCHM) **0**

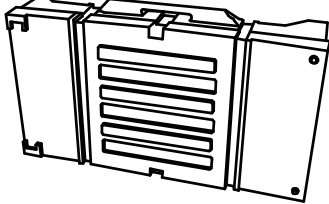

ORBITAL FREIGHT CASE
48" x 24" x 10"
(OCH) **0**

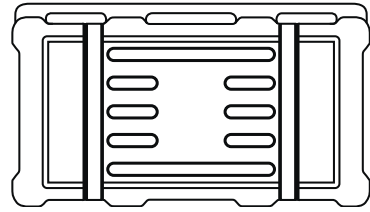

FREIGHT CASE
48" x 24" x 12"
(OCH-2) **0**

Notes: