

Linear Pro Kit 27

LN-K-3P-27

Linear Pro Kits provide a modern, slick and stylish appearance. The extrusion based exhibits feature a **NEW** velcro-applied fabric center graphic, UV printed or frosted plex headers and wings, as well as a pillowcase fabric canopy.

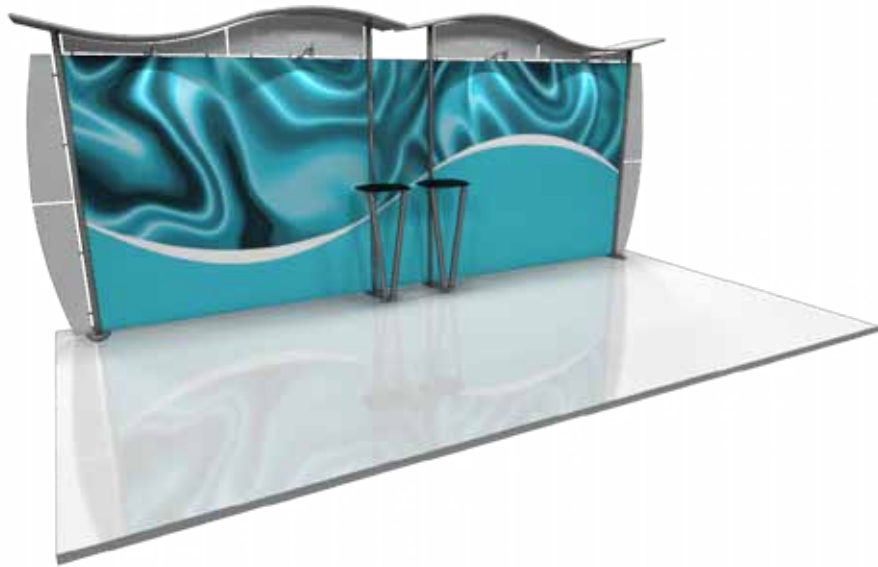

features and benefits:

- Custom appearance
- Easy to assemble
- **NEW** velcro-applied fabric center graphic
- Comes with your choice of frosted plex or PVC graphic wings and headers
- Pillowcase S-shaped fabric canopies
- Installation tool included
- Aluminum construction: vertical extrusions 75 mm x 50 mm
- Table tops available in four color options
- Kit includes four OCH cases, two v-leg tables, and four 50 watt spotlights
- Lifetime hardware warranty against manufacturer defects

dimensions:

Hardware	Graphic
Assembled unit: 120" w x 99.4" h x 27.3125" d approx. 3048mm(w) x 2525mm(h) x 694mm(d)	Header panels: Total visible area: 118.5" w x 11.05" h 3010mm(w) x 280.7mm(h)
Shipping	Wing panels: Total visible area: 10.4" w x 84" h 264mm(w) x 2134mm(h)
Shipping dimensions - ships in four cases OCH case: 48" l x 24" w x 10" h 1219mm(l) x 610mm(w) x 254mm(h)	Right and left panels: Total visible area: 93.74" w x 84" h 2381mm(w) x 2134mm(h)
Approximate shipping weight (entire kit): 275 lbs/ 124.7 kg	Center panel: Total visible area: 22.25" w x 84" h 565mm(w) x 2134mm(h)
	Total visible area: 230.3" w x 94.3" h 5849.6mm(w) x 2395.2mm(h)
	Refer to related graphic template for more information

additional information:

Panel materials:

Center graphic: Oxford

Headers & wings:

Single-sided frosted acrylic, or printed PVC

Table top color options:



We are continually improving and modifying our product range and reserve the right to vary the specifications without prior notice. All dimensions and weights quoted are approximate and we accept no responsibility for variance. E&OE. See Graphic Templates for graphic bleed specifications.

Parts Included		
Part Label	Qty	Part Description
LN-FS-UPRIGHT	x4	LN-FS-UPRIGHT - LINEAR UPRIGHT WITH FOOT
PH-1168-L-L	x8	1168MM (46") LENGTH OF PH EXTRUSION WITH CAM LOCK BOTH SIDES
PH-1067-L1	x4	1067MM (42") PH LOCK HOLE ONE SIDE
PH-567-L-L	x2	567MM PH WITH LOCK ONE END & CAP
LN-ADJ-FT	x2	LINEAR ADJUSTING FOOT
IB2	x2	INLINE BRACKET
PM3O-1067	x4	1067MM (42") PM3O OPEN ENDS
LN605-EN	x2	PH END CAP
WME-1000	x12	1000MM (39.375") WIRE MANAGEMENT EXTRUSION W/ VELCRO
LN-10X10-FG	x2	LINEAR 10X10 FABRIC CENTER GRAPHIC
LN-27-HW-A-G	x1	LINEAR KIT 27 HEADER/WING GRAPHIC A
LN-27-HW-B-G	x1	LINEAR KIT 27 HEADER/WING GRAPHIC B
LN-27-HW-C-G	x1	LINEAR KIT 27 HEADER/WING GRAPHIC C
LN-27-HW-D-G	x1	LINEAR KIT 27 HEADER/WING GRAPHIC D
LN-27-HW-E-G	x1	LINEAR KIT 27 HEADER/WING GRAPHIC E
LN-27-HW-F-G	x1	LINEAR KIT 27 HEADER/WING GRAPHIC F
LN-27-HW-E-G	x1	LINEAR KIT 27 HEADER/WING GRAPHIC G
LN-27-HW-F-G	x1	LINEAR KIT 27 HEADER/WING GRAPHIC H
LN-CAN-K-S	x2	LINEAR CANOPY KIT, S-SHAPE
LN-TBL-V-LEG-STD	x2	LINEAR V-LEG STANDARD TABLE TOP *FINISH MAY VARY
CKAPS	x20	CABLE KIT, 7MM PANEL SUPPORT (MULTI ANGLE) AKA LN-P0114-WNT1
PHFC2-150-L	x2	150MM PHFC2 W/ONE LOCK
LN-LT-FXT	x4	LINEAR LIGHT FIXTURE HOLDER
LUM 8	x4	LUMINA 8 LIGHT
ALLEN KET SET	x2	ALLEN KEY MULTI-TOOL (HEX KEY TOOL)

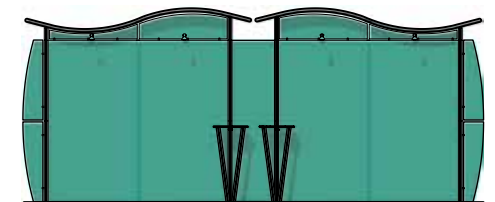
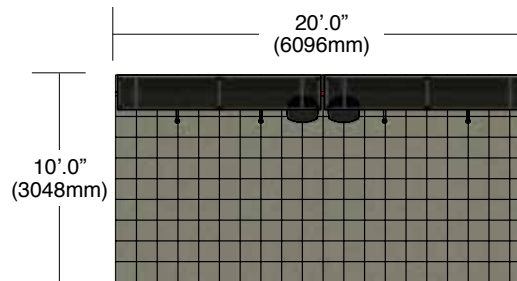
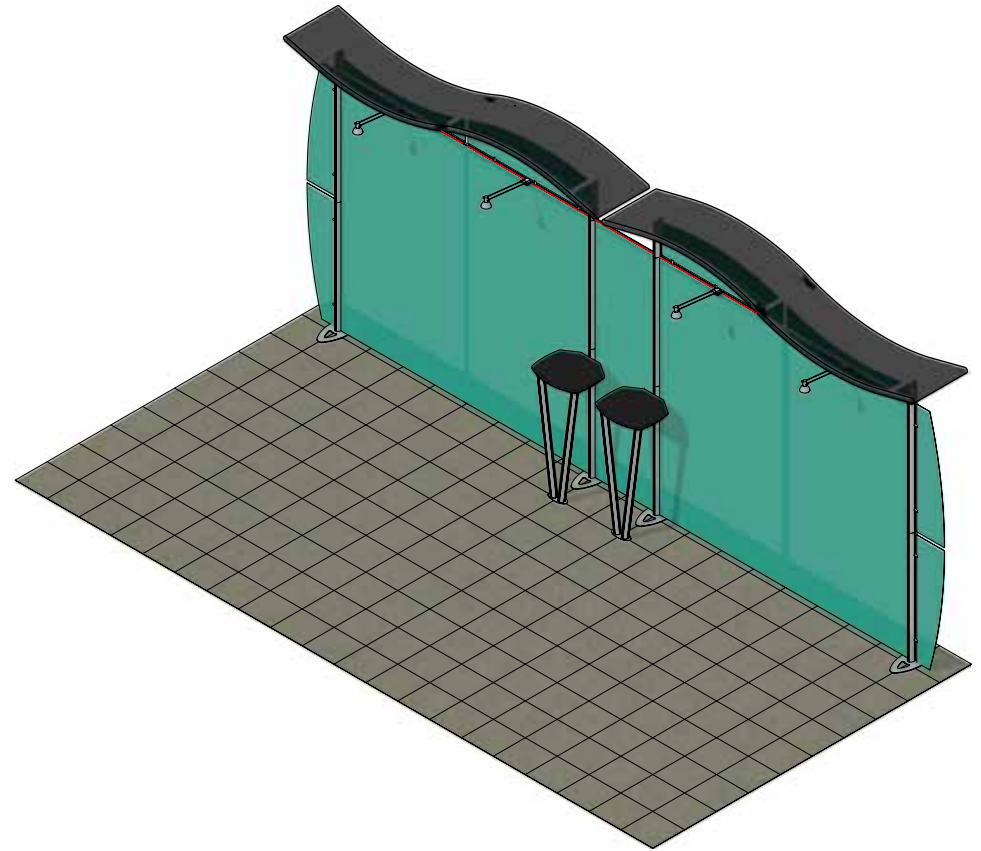

Step 1. Assemble the bottom of the frame

Using the 5MM HEX KEY, attach each PH-1168-L-L and both sides of the PH-567-L-L to the LN-FS-UPRIGHT's with the velcro facing front. Attach the opposite ends of the PH-1168-L-Ls to the PH-1067-L1 uprights using the 5MM HEX KEY. Once all are attached, use the 5MM HEX KEY to depress the IB2 lower button and insert into the top of the PH-1067-L1s, DO NOT LOCK.

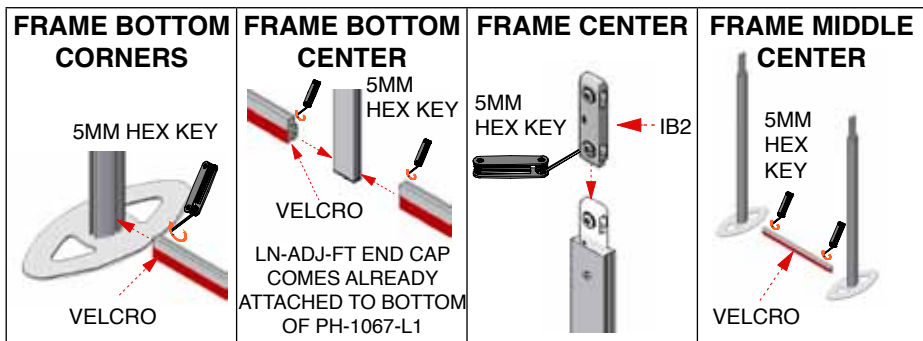
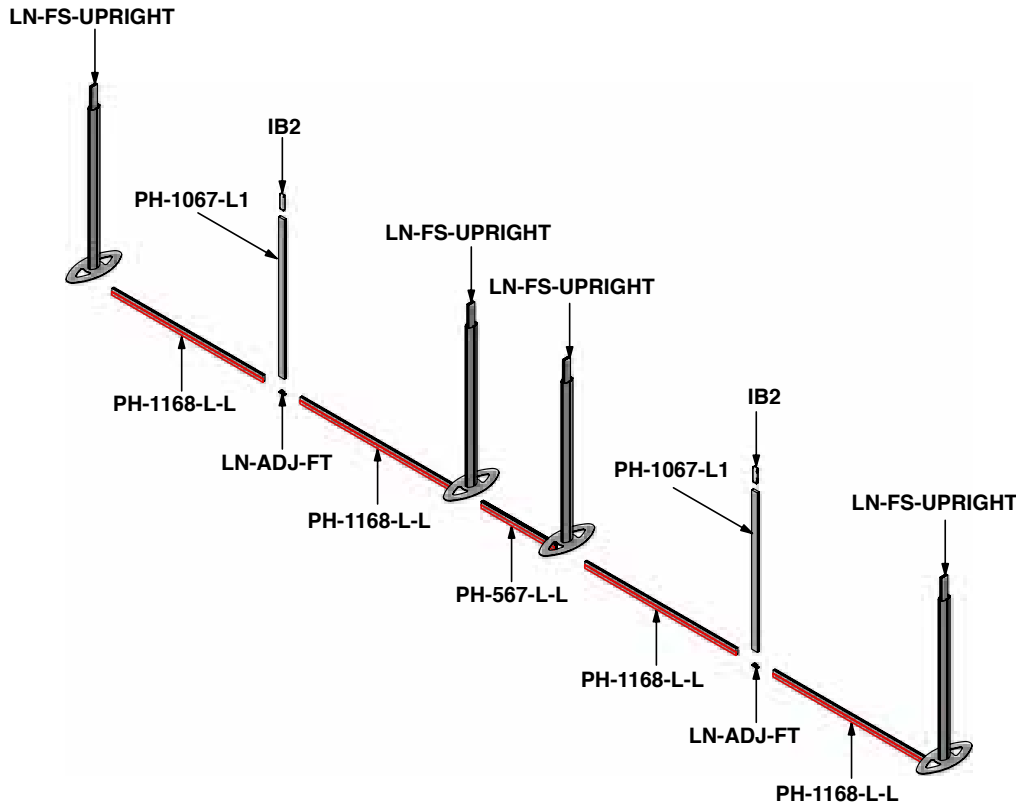

Step 2. Assemble the top of the frame

Make sure the velcro is facing towards the front and slide the left and right PM30-1067s onto the LN-FS-UPRIGHT on the left and right ends of the frame. Push in the lock button to slide and attach the two PH-1067-L1s to the IB2s below, then lock both buttons. Attach PH-1168-L-Ls and the PH-567-L-L to the PM30-1067s and PH-1067-L1s using the 5MM HEX KEY.

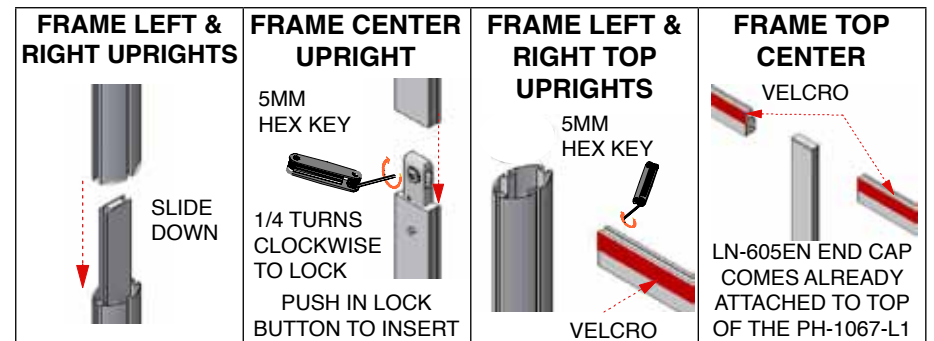
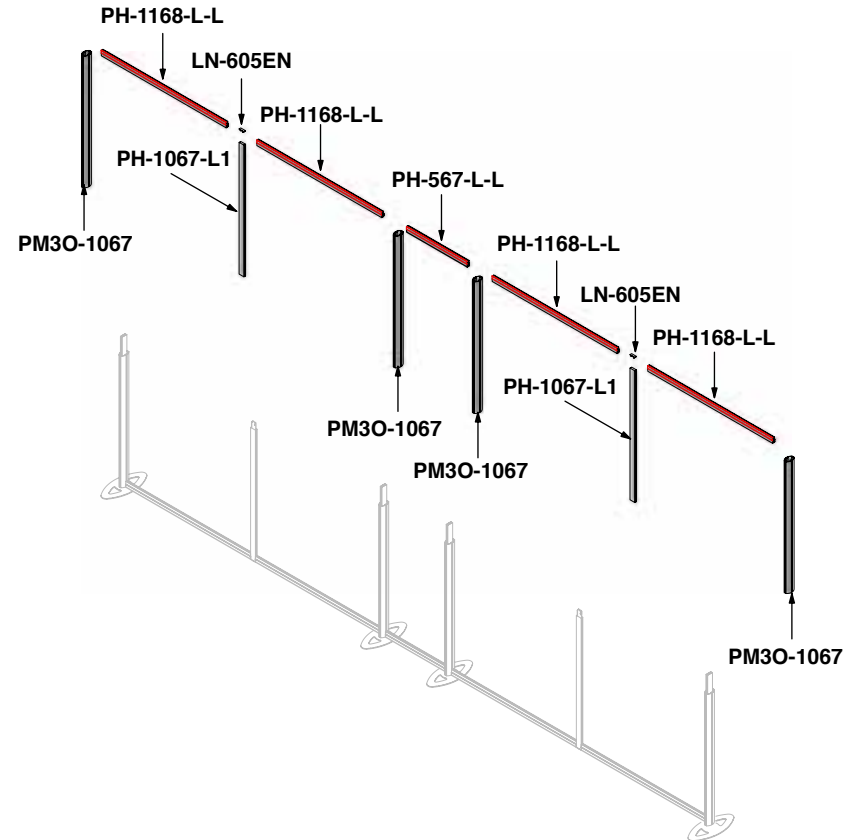

Step 3. Attach graphic support & adhere CKAPS for graphic headers/wings
 Snap attach the WME-1000 (graphic support) onto the frame inside the left and right uprights of the left, center, and right frame sections. Make sure the velcro is facing towards the front. Insert the 20 CKAPS into the outside perimeter channels and turn clockwise to lock, other locking screws should be loose. Evenly space out the standoffs for each header or wing.

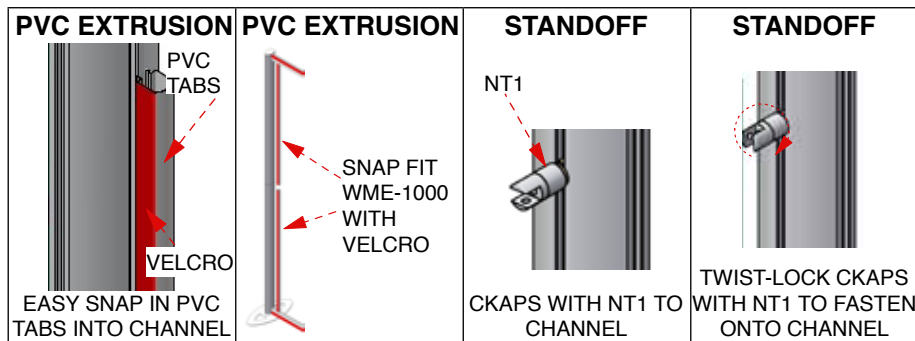
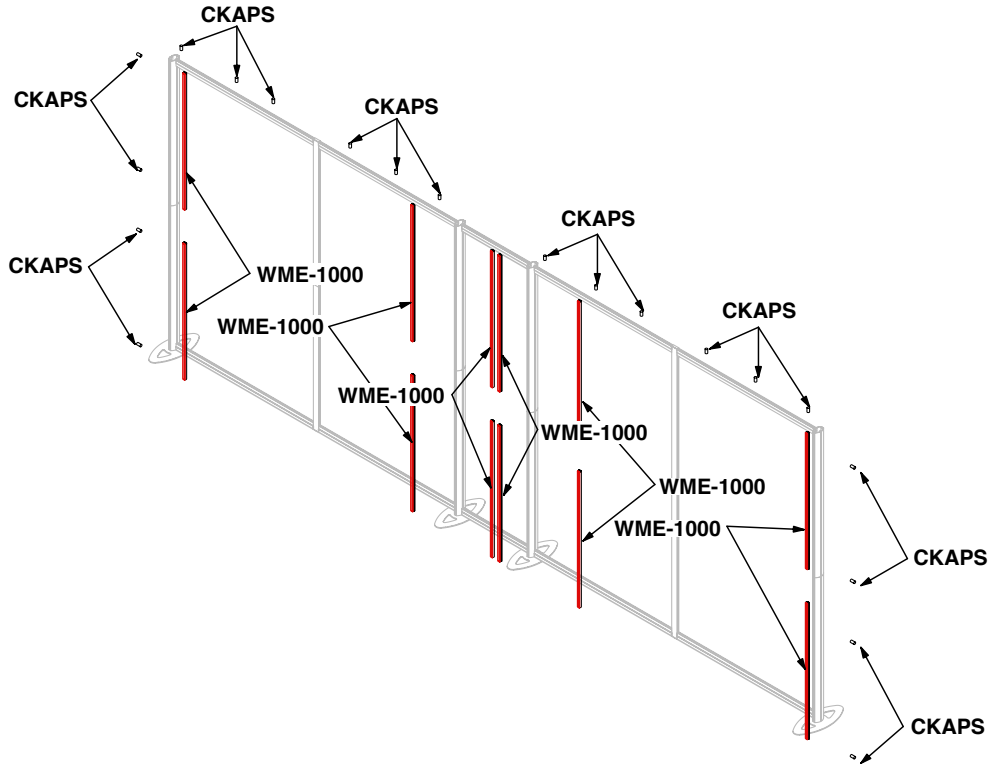

Step 4. Attach graphic headers/wings, right and left graphic, and center graphic
 Insert the wings and headerpanels into CKAPS 7mm wide channel, lock in the panels and tighten all of the screws. Velcro attach the LN-10X10-FG (left & right large fabric graphics) and the LN-C-FG (center fabric graphic) to the frame starting at the top left corner. Continue to velcro attach the graphics to the frame ending in the bottom right corner.

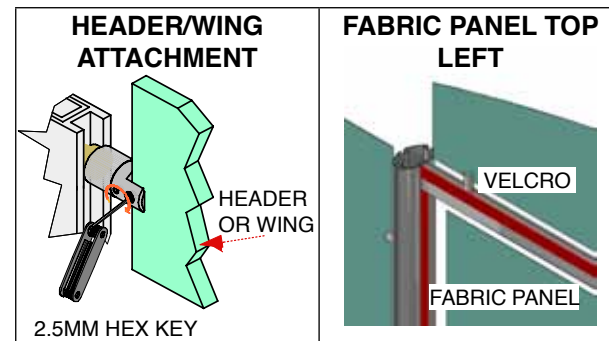
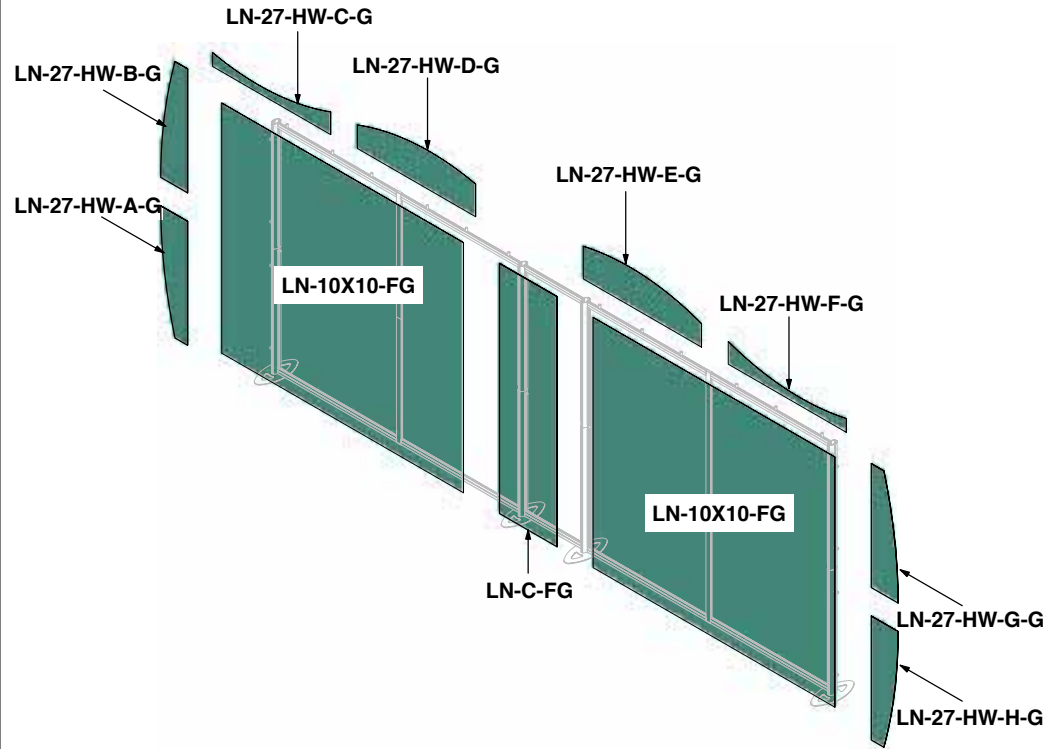

Step 5. Attach s-shaped canopies

Assemble each frame in order using the number key to attach the tubes and hubs. Pull over the pillowcase and insert the screws through frame parts 1, 7, and the pillowcase slots. Loosely fasten canopy post mounts to screws, DO NOT ZIPPER. Last, slide the post mounts onto the frame and tighten using the 8MM HEX KEY, then zipper the pillowcase. Repeat for the second canopy.

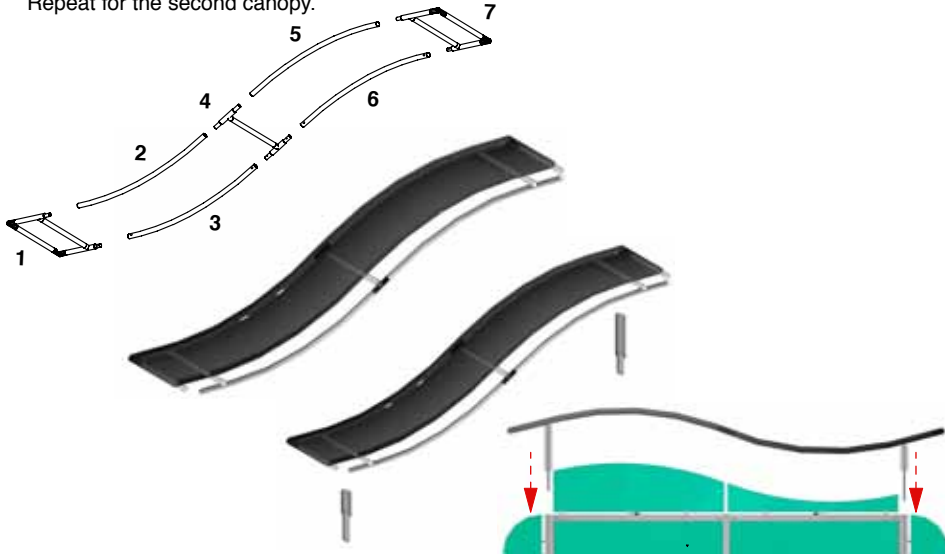

<p>C-CANOPY FRAME</p> <p>PUSH PINS TO ASSEMBLE THE FRAME</p>	<p>C-CANOPY PILLOW CASE & SCREW</p> <p>PILLOW CASE SCREWS SLOTS</p>	
<p>C-CANOPY SCREW & SHORT POST</p> <p>SHORT POST</p> <p>LOOSELY FASTEN CANOPY POST MOUNTS TO SCREWS</p>	<p>C-CANOPY POST TO BACKWALL</p> <p>SLIDE IN POST MOUNTS ONTO FRAME</p>	<p>C-CANOPY POST TO BACKWALL</p> <p>TIGHTEN SCREWS WITH 8MM HEX KEY THEN ZIPPER PILLOW CASE</p>

Step 6. Assemble lights & tables & attach to backwall

Slide the light fixture LUM-8 onto the light clip LN-LT-FXT. Lift and rest light clip onto top of horizontal channel and run the wires in between and behind the panels. Slide the PHFC2-150-L into the underside of the table. Fasten the table legs to the underside of the table top using the THUMB SCREWS. Once finished turn table over and attach it to the backwall frame (LN-FS-UPRIGHT) using the 5MM HEX KEY on the PHFC2-150-L. Repeat for the second table.

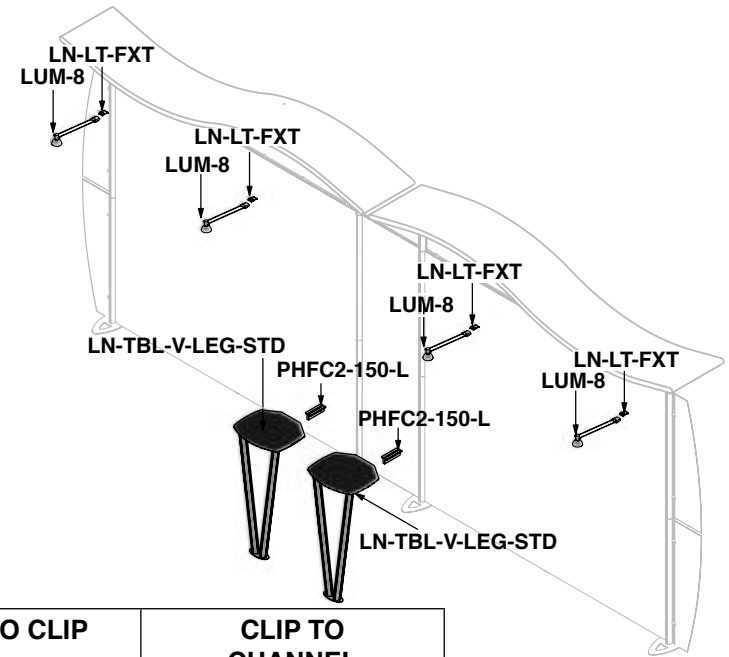

<p>LIGHT TO CLIP</p> <p>LN-LT-FXT LUM-8</p>	<p>CLIP TO CHANNEL</p>	
<p>TABLE TOP</p> <p>PHFC2-150-L</p> <p>ATTACH PH END CAP TO PHFC2-150-L</p>	<p>TABLE LEG</p> <p>APPLY V-LEG ONTO UNDERSIDE OF TABLE WITH THUMB SCREWS</p>	<p>TABLE SETUP</p> <p>LN-FS-UPRIGHT</p> <p>5MM HEX KEY</p>

Check out these related products:

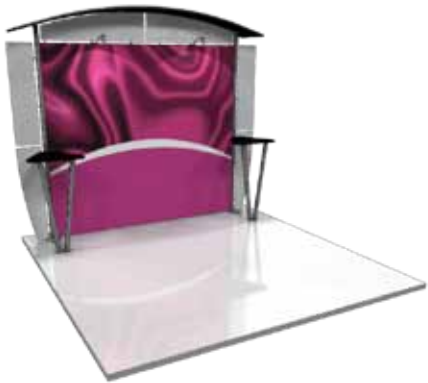

Linear Pro Kit 22

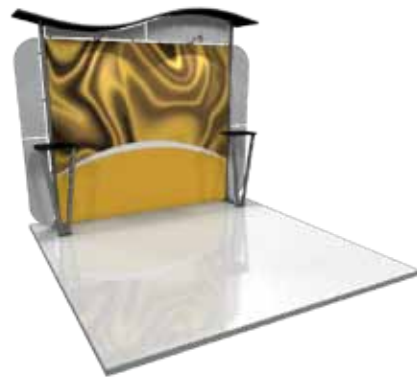

Linear Pro Kit 25

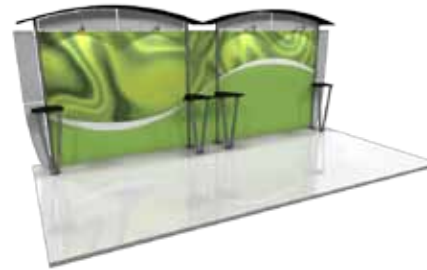

Linear Pro Kit 26

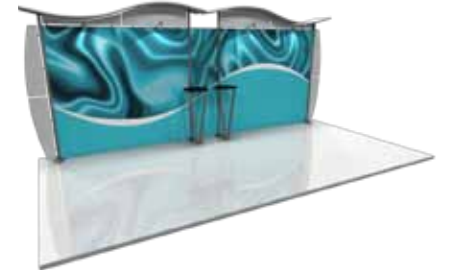

Linear Pro Kit 27
