

# LUMIÈRE CONFIGURATION - B

LUMIÈRE LIGHT WALL

PRODUCT CODE: LLW10B



On frame On graphic

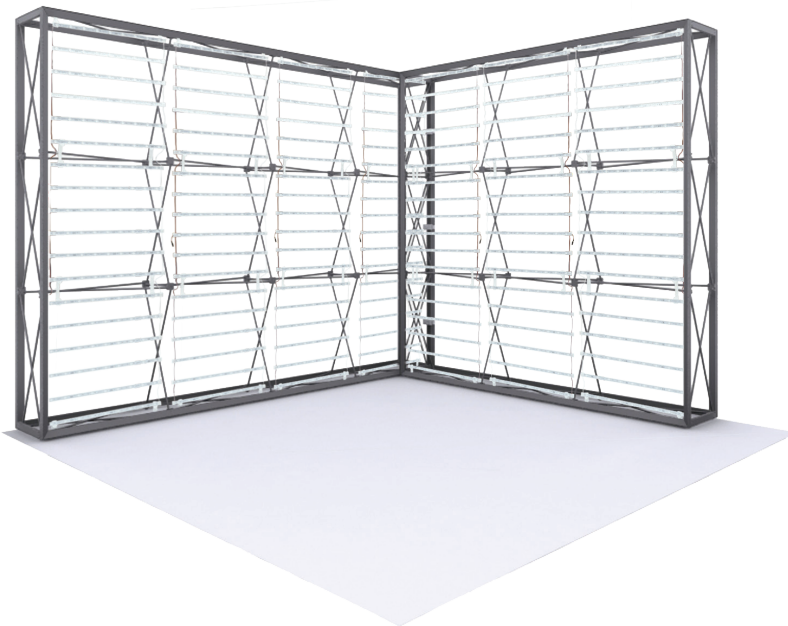

L Link Connector

## PRODUCT DESCRIPTION

Illuminate your message with the Lumiere Light Wall! Lumiere ladder lights make backlit graphics pop on this innovative combo display of silicone-edge graphics and portable RPL fabric pop ups. Plus, the Lumiere shrinks down in size: simply collapse the geometric frame and the SEG bungeed channel bars, and fold or roll the fabrics graphics. Setup requires 1 person and 5-10 minutes. SEG portability is easy and stylish.

<b>DISPLAY DIMENSION</b>	236.2" W x 88.6" H x 14.5" D
<b>GRAPHIC DIMENSIONS</b>	
<b>4X3 MAIN GRAPHICS</b>	118.5" W x 89" H (2 Graphics)
<b>4X3 END CAP GRAPHICS</b>	14.25" W x 89" H (1 Graphic)
<b>3X3 MAIN GRAPHICS</b>	89" W x 89" H (2 Graphics)
<b>3X3 END CAP GRAPHICS</b>	14.25" W x 89" H (1 Graphic)

## GRAPHIC MATERIAL

UV Backlit Fabric

## GRAPHIC FINISHING

Silicone beading is sewn around the perimeter of the fabric graphic. Silicone beading is hidden from view once installed.

## DISPLAY CONSTRUCTION

Aluminum Frame

## LADDER LIGHTS SPECIFICATION

<b>EACH LIGHT BEAD</b>	0.8W
<b>ANGLE</b>	160°
<b>OPERATING VOLTAGE</b>	DC12V/24V
<b>TOTAL WATTAGE</b>	906.4W
<b>TOTAL AMPERAGE</b>	75.6A

## TRANSFORMER SPECIFICATION

<b>OUTPUT</b>	12V/29A
<b>INPUT</b>	100-120VAC/6.8A 200-240VAC/3.4A 50/60Hz

## SHIPPING WEIGHTS & DIMENSIONS

Lumiere Ladder Lights (2 boxes total)	
Shipping Weight	31 lbs (each box)
Shipping Dimensions	13" L x 12" W x 37" H (each box)
4x3 Lumiere Light Wall (1 box)	
Shipping Weight	35 lbs (frame only) 39 lbs (with graphics)
Shipping Dimensions	34" L x 14" W x 9" H
3x3 Lumiere Light Wall (1 box)	
Shipping Weight	28 lbs (frame only) 32 lbs (with graphics)
Shipping Dimensions	34" L x 14" W x 9" H

## GRAPHIC TURN AROUND TIME

2 business days after proof approval

<b>AVAILABILITY</b>	CA and PA
---------------------	-----------

## AVAILABLE ACCESSORIES



La Caja Case



Tahoe Case



Hard Case Podium



Medium Hard Case



Half Hard Case



Genie Counter Case

# LUMIÈRE CONFIGURATION - B

LUMIÈRE LIGHT WALL

PRODUCT CODE: LLW10B

## PARTS LIST



Qty 1 - 4x3 Pop Up Frame



Qty 1 - 3x3 Pop Up Frame



Qty 4 - 4 Section  
Channel Bars



Qty 10 - 3 Section  
Channel Bars

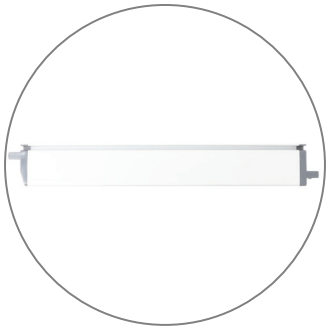

Qty 8 - End Cap  
Channel Bars



Qty 2 - Carry Bag



Qty 2 - Channel Bar Bag

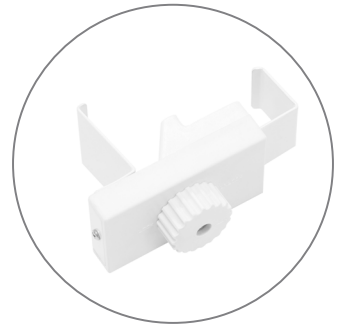

Qty 3 - L Link Connector



Qty 7 - Ladder Lights



Qty 7 - Transformers



Qty 2 - Transformer  
Power Cord



Qty 7 - Male / Female  
Transformer Connector  
Cords



Qty 28 - Top/Bottom  
Middle Light Brackets



Qty 28 - Top/Bottom  
Light Bracket

# LUMIÈRE CONFIGURATION - B

LUMIÈRE LIGHT WALL

PRODUCT CODE: LLW10B

## SET UP INSTRUCTIONS

### Set Up Pop Up Frame



**a.** Place frame with the adjustable feet facing down.

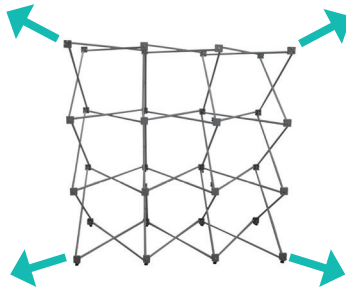

**b.** Expand the frame.

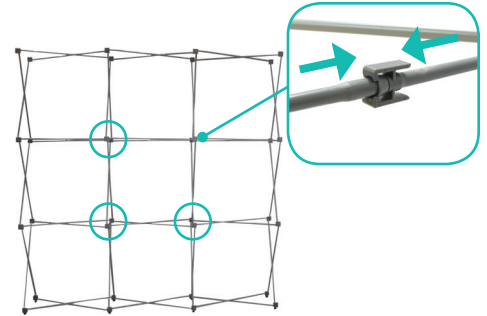

**c.** Close frame by pushing the outside of the frame until male and female ends connect.

### Insert Channel Bars

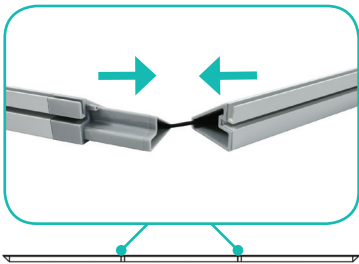

**a.** Expand each channel bar. Follow bungee to connect.

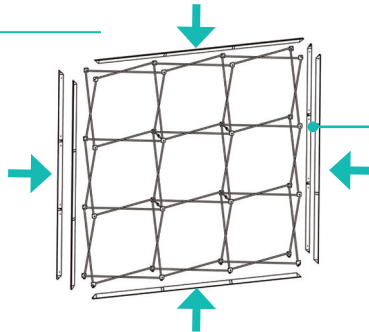

**b.** Attach channel bars to frame.

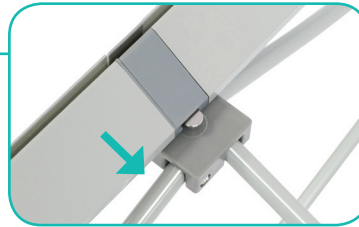

**c.** Slide channels bars onto frame, from top to bottom, then secure onto metal peg.



**d.** Attach the top and bottom end caps on each side of the frame.

### Hook Ladder Lights



**a.** Hang ladder lights by placing the brackets on the top and bottom of the frame.



**b.** Snap brackets onto ladder lights. Then place brackets on the top and bottom middle frame.

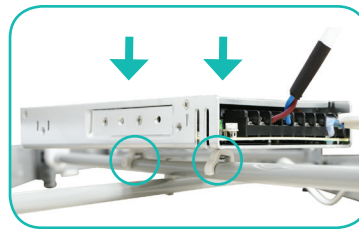

**c.** Place transformers on the bottom of the frame by snapping onto the cross sections.

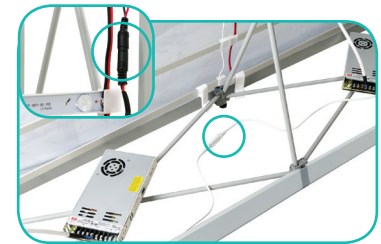

**d.** Connect all wire transformers and ladder lights together. Then plug each transformers together.

### Install Graphic



**a.** In each corner, insert the silicone edge beading into the groove.



**b.** Then insert the remainder of the beading. Repeat backlit installation for the back frame.



**c.** Then repeat graphic installation on the end caps for each side.

# LUMIÈRE CONFIGURATION - B

LUMIÈRE LIGHT WALL

PRODUCT CODE: LLW10B

## SET UP INSTRUCTIONS

### Connecting Return Wall

Front View

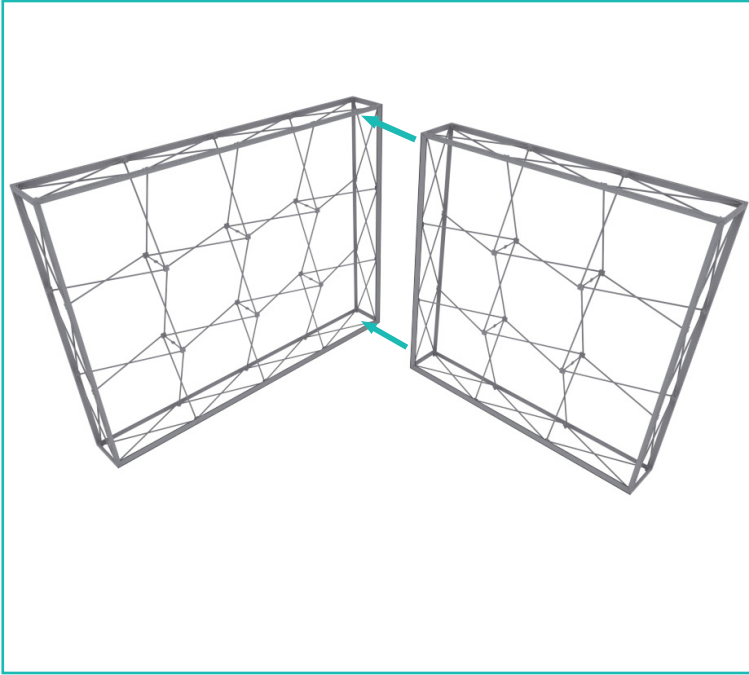

Back View

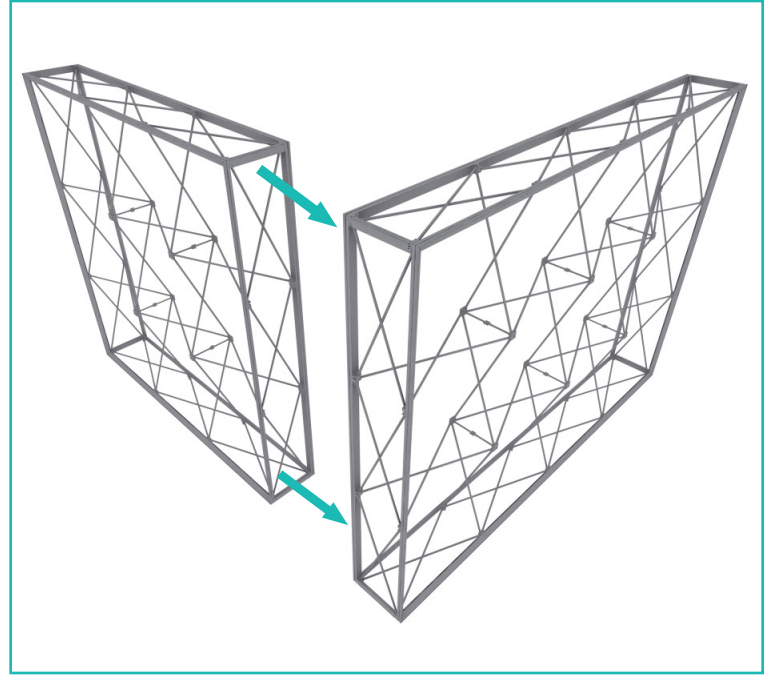

Adjoin the 3x3 frame perpendicular (90° angle) to the front side of the 4x3 frame.

**Note:** Rendering shown without graphics for clarity. 4x3 front side graphic must be installed before connecting frames.

### L Link Connection



\*Starting from behind, pull the 4x3 graphic away to make space for L Connector.



Slide L Connector onto the channel bars of both frames.

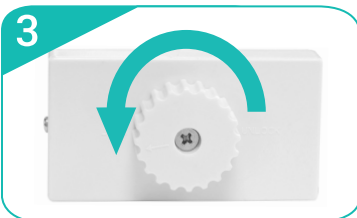

Turn dial to the left to lock the L Connector in place. Repeat for each vertical section (3 total).

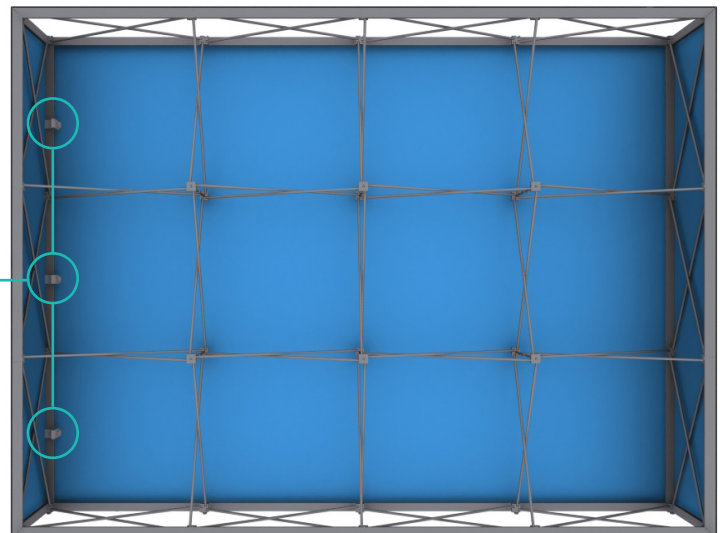

\*Back side of 4x3 shown above.

# LUMIÈRE CONFIGURATION - B

LUMIÈRE LIGHT WALL

PRODUCT CODE: LLW10B

## TEMPLATE GUIDE

### Front View

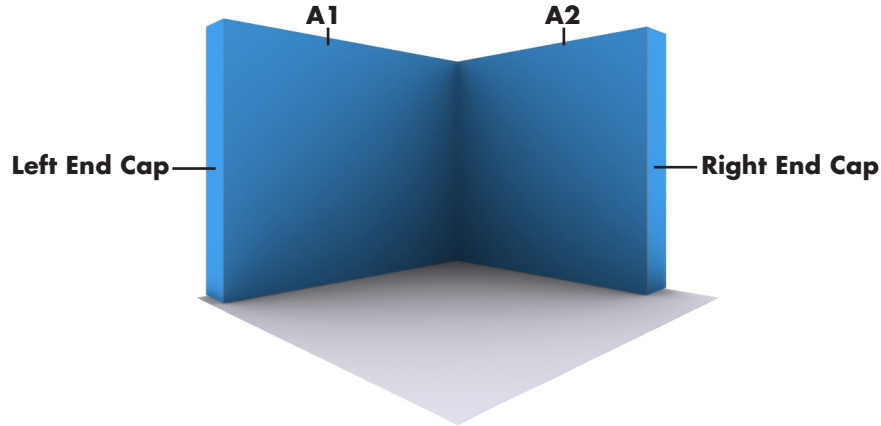

### Back View

